

Mechanical Structures for Robotic Hands based on the “Compliant Mechanism” Concept

F. Lotti ⁽¹⁾, P. Tiezzi ⁽¹⁾, G. Vassura ⁽¹⁾, A. Zucchelli ⁽¹⁾

⁽¹⁾*DIEM - Department of Mechanical Engineering, University of Bologna
Viale Risorgimento, 2, 40136, Bologna, Italy
Email: gabriele.vassura@ mail.ing.unibo.it*

INTRODUCTION

Many dexterous and anthropomorphic robot hands have been presented in the recent years (see e.g. [1], [2], [3], [4], [5], [6]), and a general new growth of interest for this kind of robotic devices can be observed. This is due on one side to the consideration that these devices are still far from the desired level of dexterity, reliability and applicability; on the other to the growth of specific interest to humanoid robots capable of substituting human intervention in a wide set of tasks where human-like manipulation skill is required.

It is the case of many time-consuming and repetitive tasks inside or outside space-stations, that a humanoid robot could perform substituting astronauts. Apart the evident reduction of astronaut's exposure to risk, this substitution could be justified, even for intra-vehicular activities, by the consideration that astronaut's time is a limited and very expensive resource and cannot be wasted accomplishing trivial tasks.

The development of dexterous robonaut hands is considered an important goal for robotic research and several projects have been purposely oriented to this application, in order to obtain design solutions compatible with the severe space-application requirements (see for example the Robonaut hand by NASA-JPL [7, 8]).

Among the many problems specifically related to space application, many of them concern mechanical design: the high complexity of hands developed so far is critical as far as size, weight and reliability are concerned. In particular, the structure of these hands, composed by hundreds of separate parts assembled together, may be very sensitive to dynamic actions, like shock and vibrations that occur during a space mission.

It is shared opinion that a consistent reduction of the mechanical complexity of dexterous robotic hands may significantly contribute to solve many application problems, representing a worthy goal for research and design.

Among the possible ways to achieve design simplification, the adoption of concepts different from those traditionally ones, eventually inspired to biological models, seems to be very promising.

This paper describes the main guidelines for the development of a dexterous robotic hand specifically oriented to mechanical design simplification.

MECHANICAL DESIGN AND RELIABILITY ISSUES

Failure Mode and Effect Analysis (FMEA) is a well known technique to investigate the sources of unreliability in a technical system, to evaluate the effects and the related levels of risk and to define possible mitigation measures. In the case of a robotic dexterous hand failure modes can be related both to structural failure of components or subsystems and to functional failure in performing the prescribed task (e.g. loss of grasp stability due to an external disturbance that exceeds sustainable limits). A pre-concept FMEA of a generic robotic hand has been developed considering the functional and the component failure modes [9]. To describe the robotic hand tasks, five basic actions have been considered (Contact application, Hold, Manipulate, Contact removal). Analysis outlined that the mechanical system is involved with higher frequency in the functional failure of hold and manipulate actions. Purposely oriented mechanical design can help preventing failure modes or their effects, acting along these main directions:

- providing the best conditions in the interaction between the hand and the grasped objects, which means to increase contact extension, robustness and stability by means of properly designed soft pads interposed between the object and the skeletal structure of the finger, as it happens in the human hand; many authors have demonstrated both theoretically and experimentally (see e.g. [10, 11, 12]), that contact surface compliance is not an optional property, but a real factor of grasp stability enhancement and an efficient way to prevent functional failures;

- reducing the risk of structural failure due to insufficient strength of structures and components; high strength does not necessarily mean high stiffness, therefore valid alternatives to metallic materials, like plastic materials and composites, can be taken into consideration in finger structure design;
- reducing the risk of failure due to problems occurring inside joints and transmissions, like jamming and self-locking or connection loosening between assembled parts; lowering the overall part count, e.g. by integration of separate parts into one-piece design, can greatly improve reliability against loosening in case of intensive shock and vibration;
- adopting design solutions intrinsically safe with respect to failure of other subsystems (e.g. non back-drivable or self-locking) transmissions.

A design concept capable of significant contributions to reliability improvement together with weight and cost reduction is the compliant mechanism concept: its application to robotic structures has been so far very marginal, but the recent evolution of control techniques capable of dominating the problems arising from structural compliance allow to consider it a potential resource to innovate hand design.

COMPLIANT MECHANISMS AND ROBOTIC HANDS DESIGN

According to the definition proposed by Howell [13, 14, 15], a compliant mechanism is a system where relative motion between rigid links is allowed by deformation of compliant elements (*hinges*) connecting the links themselves. Many traditional mechanisms, including robotic finger structures, can be redesigned applying this concept (see Figure 1).

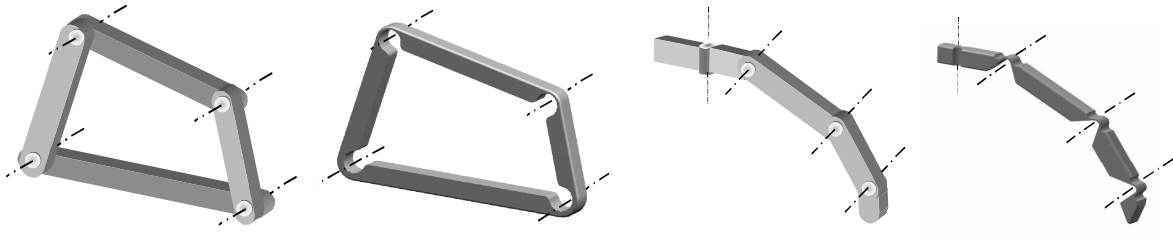

Fig. 1. Alternative design of mechanisms

Previous applications in robotics, see e.g. [16], were limited to small displacement grippers, but the concept seems promising also for application in anthropomorphic hands, with these main advantages:

- design simplification, with reduction of part count, avoidance of part-interface problems (friction, wear, backlash), size and bulk reduction, adoption of alternative materials, etc.
- high potential of reliability improvement, in particular with respect to part loosening;
- manufacturability enhancement and overall cost reduction, obtainable with proper choice of materials and processes in spite of the growth of shape complexity.

The main drawbacks and design problems are:

- the compliance of hinges introduces severe problems in modeling and control of the equivalent kinematical chains and the overall stiffness of the structure is reduced also with respect to transverse bending and torque loads;
- structural design must cope with the need of large hinge displacements, with non trivial problems as far as fatigue life is concerned;
- there are deep interactions between all the parts of the mechanical system (articulated structure, actuation and compliant cover of the hand) so that a co-design of all these subsystems must be performed; this makes the design decisional path very complex and difficult to be optimized [17, 18].

In addition to the evident advantages related to structural simplification and reliability enhancement, a strong motivation to apply the compliant mechanism concept to robotic hand design comes from the full compatibility of this approach with an efficient reproduction of the endoskeleton model offered by the human hand: An endo-skeletal structure obtained with a reduced cross-section internal frame, instead of the frequently adopted exo-skeletal design, offers much better possibility to host distributed sensory equipment and compliant pads, both essential for dexterity achievement and operation reliability improvement.

For the above reasons, with the aim to explore new ways in design of robotic hands and to check what could be offered by application of concepts different from the traditional approaches, the development of a new robotic hand, called UB Hand III, recently started at the University of Bologna; in the following, both the general design guidelines and the first

implementation results are presented. The idea of investigating alternative mechanical configurations was born during the development of the Marviss Project, a feasibility study for a dexterous anthropomorphic gripper to be used inside a space-lab for simple manipulation tasks originally destined to be performed by human operators; the Marviss Project was committed by TecnoSpazio S.p.A according to specifications defined by ASI, the Italian Space Agency, where safety and reliability requirements were particularly focused on.

FEASIBILITY ANALYSIS OF A NEW HAND

We specifically address the goal of structural simplification while maintaining the capability to perform internal manipulation tasks. With reference to Figure 2, where different classes of robotic hands are placed according to their levels of anthropomorphism and dexterity [19], the goal is to design a hand where full anthropomorphism is joined to a high level of dexterity. This means that the fingers must have a proper number of controlled degrees of freedom and that simplified configurations, e.g. underactuated fingers, are not allowed.

According to these assumptions, fingers with joints made with compliant hinges and two or three degrees of freedom have been considered. Joint actuation is supposed to be provided by flexible items (tendons or flexures) that slide along guides inside each link and are connected to remote, single or double-acting, linear actuators.

The finger scheme presently adopted, shown in Figure 3 in its 2 dof implementation, is the result of a systematic evaluation of alternative configurations: it minimizes the number of flexures (one per each joint) but requires that these flexures can work both under tension and under compression loads. With the adopted configuration, compression loads are very low and occur only during the hand-opening phase, while only tension loads are required to exert contact forces when the hand closes to grasp the object. The distal joint is connected to the medial joint, which is independently actuated as well as the proximal joint. Therefore in the finger plane there are three joints but only two degrees of freedom: this configuration reproduces the behavior of the human finger and has been adopted in previous hand projects (e.g. DLR hand [4]).

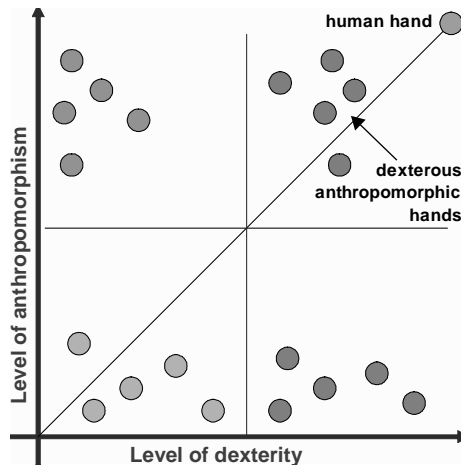

Fig. 2: Anthropomorphism vs dexterity

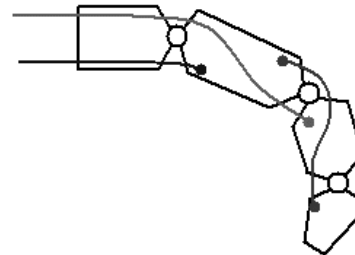

Fig. 3: Scheme of the adopted finger configuration

The capability of such a structure to control fingertip trajectories is demonstrated by kinematical simulations: in Figure 4 the required displacements of flexures, X_m and X_p , are plotted in the case of a reference circular trajectory, together with the correspondent flexure loads, T_m and T_p and T_d . In the model, the bending stiffness of the external compliant layer has not been considered and the hinge stiffness has been assumed to be constant along the whole joint rotation.

The values of the loads acting on the flexures can be varied by changing the stiffness of the hinges and by adopting a non-aligned configuration for the relaxed finger structure. Assuming each joint to be required to perform a total 90 degree angular displacement, it is preferable have a relaxed configuration with links forming non-null relative angles (e.g. 45°). In operation, in order to reach the straight or full-bent configuration, each hinge will have to bend upwards or downwards for a reduced excursion, thus limiting the maximum strain imposed to the hinge material.

For what concerns the technological implementation, the need of getting, for hinges and flexures, large bending strain without overcoming material strength leads to the adoption of materials with a high ratio between the ultimate yield

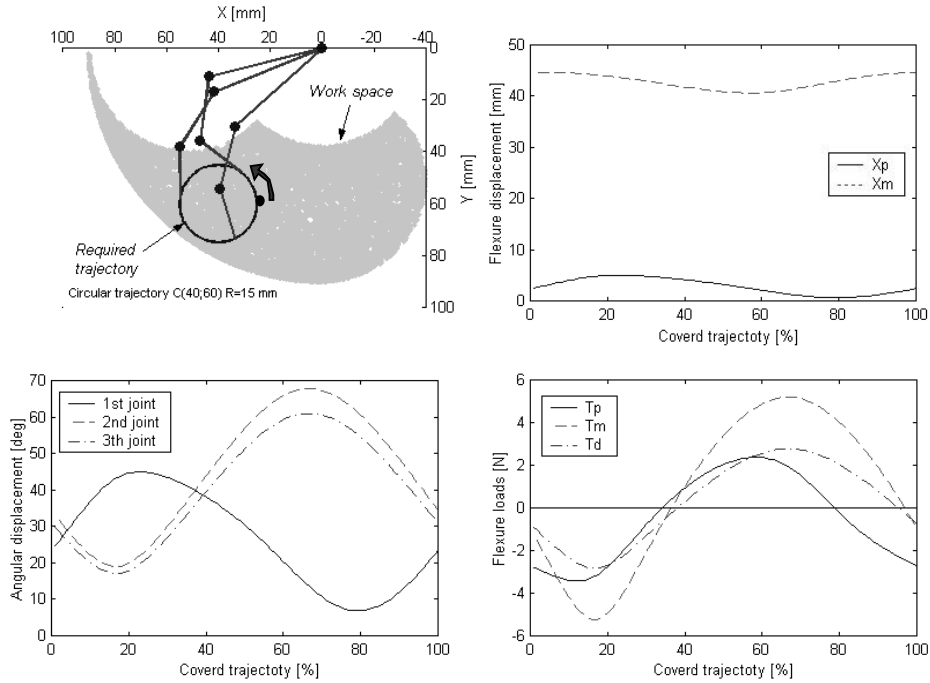

Fig. 4: Simulation of a circular trajectory

strength and the Young modulus (see Howell in [13]). In addition, a high value of the Young modulus in the case of flexures can be useful to prevent buckling under compression loads. Furthermore, the materials are required to be easily manufactured even in presence of complex and very slender item shapes. For all these reasons, plastic materials have better chances with respect to metallic materials, as shown in Table II.

As to design for manufacturing, different approaches have been evaluated and Figure 5 summarizes three main design patterns, based on the adoption of same or different materials for links, hinges and flexures respectively.

The pattern of Figure 5a allows a fully integrated design, which simplifies assembly and enhances reliability but greatly complicates die design and casting operations; furthermore, flexures and their guides are made of the same material, with non optimal properties in terms of friction and wear.

The pattern of Figure 5b allows optimization of material choice for the hinges and the flexures, in terms of structural behavior and of sliding contact tribology; this solution simplifies die design and costs and ensures better quality control, but increases part count and complicates assembly operations.

The pattern of Figure 5c can be considered in the case that hinges can not be made of the same material of links (e.g. hinges made of high strength steel, links made of moulded plastics); inclusion of hinges into plastic links during moulding could be a way to avoid structural discontinuity and assembly problems.

At present attention is mainly oriented to patterns 5a and 5b. A preliminary design of a finger structure according to pattern b is shown in Figures 6 and 7, that respectively show the module as it should result from the moulding process and after the assembly process, which simply consists on placing the flexures inside their guides and in bending the lateral closure elements. The technological feasibility has been checked with a qualified company that applies advanced plastic moulding technology. Among the several candidate materials, acetal resins, with eventual additives to improve bending fatigue resistance, are favourite in the case of design pattern 5a, while in case of pattern 5b a frame in PEEK (Polyetheretherketone) and tendons in POM (Polyoxymethylene) are under evaluation.

As above discussed, a crucial design issue is that the hand surface, in particular each finger module, can be covered with a thick compliant layer in order to increase contact adaptability to object shape and therefore grasp robustness and stability.

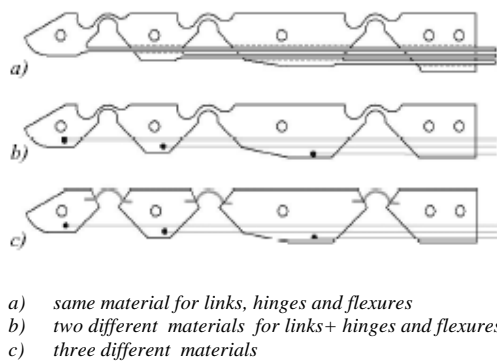

MATERIAL	Young's modulus E (MPa)	Yield strength Sy (MPa)	Sy/E x 1000
Teflon (PTFE)	345	23	66,7
Delrin	2068	69	33,4
Nylon (type 6)	2620	81	30,9
E-glass (73,3vol%) in epoxy	56000	1640	29,3
Polypropylene	1400	34	24,3
Polyethylene (HDPE)	1400	28	20,0
Steel (Sandvik 11R15)	186000	1950	10,5
Titanium Ti-13 heat treated	114000	1170	10,3
Aluminum 7075 heat treated	71100	503	7,1

Fig. 5: Different technological design solutions and material properties

The material considered for this application is a polyurethane gel, which exhibits the following interesting properties:

- with a proper mix of the basic components (polyol and isocyanate) it can provide a softness comparable with that a biological tissue; furthermore, it exhibits a remarkable visco-elastic behaviour, with characteristic parameters that stay in the range of values considered optimal;
- it can sustain without breakage very high strain, up to 500%, and is therefore compatible with large shape variations of the covered objects;
- the material has a great thermal stability, it is not flammable for a wide range of application temperature, degasification is very low even under high vacuum, it can be easily spray-coated with polymeric skin in order to increase tear resistance;
- it shows a good adhesivity to metallic and plastic surfaces and can be moulded at ambient temperature and pressure, with reduced temperature changes during polymerization; this allows to suppose that the inner articulated frame could be included into the compliant cover during its mould phase provided the polymerizing liquid is prevented from entering critical regions like joints or flexure guides.

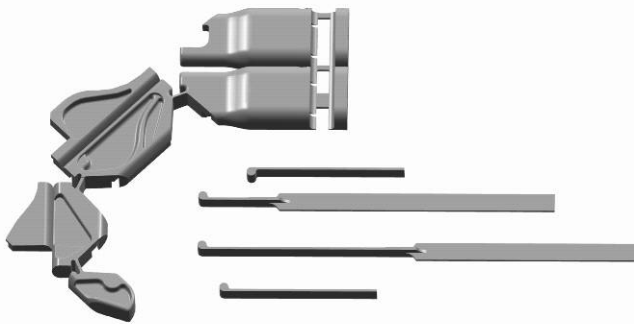

Fig. 6: Moulded finger module



Fig. 7: Assembled finger module

In Figure 8 a sketch of the modular articulated frame included into the external soft cover is presented.

The proposed finger modules can be assembled in different ways in order to obtain the overall hand architecture: in Figure 9 a feasibility study for a five fingered hand is presented. The general hand architecture is based on the availability of different finger modules for upper fingers and for thumb, connected to a palm where the actuating flexures of each finger can be routed through. Actuation is supposed to be remote and placed in the forearm, but the scheme could be easily modified in case of actuators placed in the back of the palm. It is just a preliminary feasibility evaluation, with many problems still to be solved (especially as far as sizing of flexures and their guides is concerned) but it allows understanding the great potential of design simplification offered by this approach.

With a few items of moulded plastic the kinematical structure of a complete hand can be assembled. The morphology of these parts will be complex, but quite feasible by means of current technology. As to the ultimate strength of the structure, probably it will not be as high as in the case of metallic structures, but surely will be enough for the majority of practical tasks. The reduction of structural stiffness, due to the presence of elastic hinges, and the presence of contact compliance, due to soft pads, will probably require grasp procedures based on impedance control, as demonstrated by several recent contributions [see 20, 21, 22, 23].

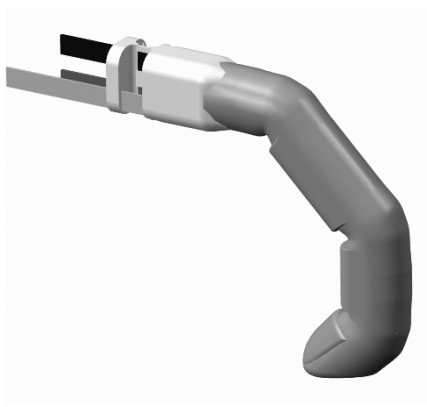

Fig. 8: Finger module with its compliant cover

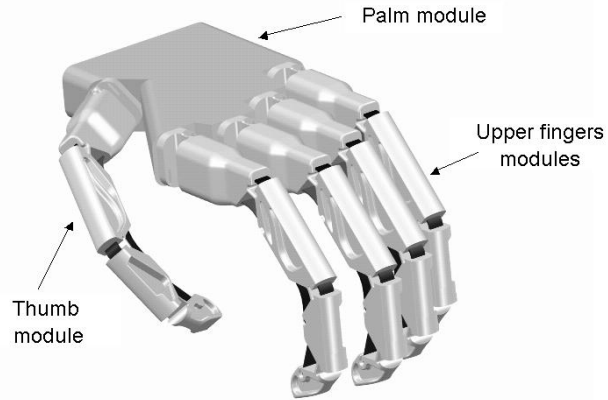

Fig. 9: Different views of a feasible hand configuration

FINGER PROTOTYPE IMPLEMENTATION AND EARLY EXPERIMENTS

In order to perform preliminary investigation on best morphology, kinematical behavior and technological aspects, different prototype fingers have been built and tested. The finger structure currently under test has a structure obtained in machined plastic material (PTFE), with three joints and two degrees of freedom (the distal joint motion is connected to medial joint rotation). A test-bed with two linear actuators provides motion to a flexure-based transmission system. Tests are made in order to evaluate both the mechanical behavior of the structure itself (durability, hinge and overall stiffness) and its kinematic behavior (e.g. trajectory accuracy and repeatability). In Figure 10 a) the one-piece structure of the finger is presented, as it comes out from manufacturing (left) and after that the flexures have been routed inside the links (right); in Figure 10 b) the experimental set-up and an early experiment of trajectory tracing are presented. Trajectory control at present uses position information generated at actuator level and the kinematical model assumes that hinges behave like a revolute pair with rotational stiffness.

So far, repeatability resulted fairly good but accuracy rather poor, probably due to inadequate modelling of hinges and flexure bending. Also considering that design is far from complete optimisation, that system modelling is almost rough, that no sensory feedback is now present along the finger joints, these results can be considered encouraging towards further development.

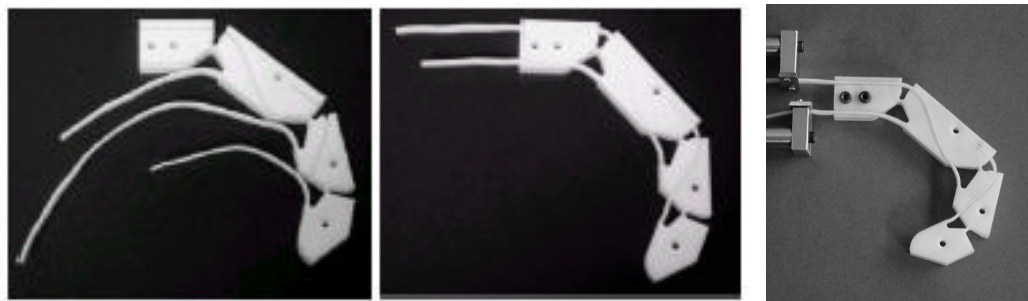

Fig.10 a): A 2 – dof prototype finger

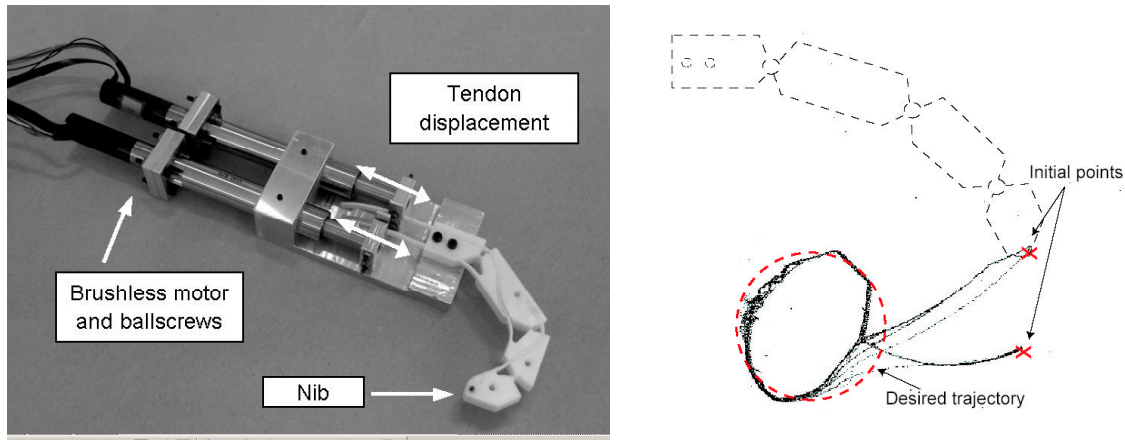

Fig.10 b): Experimental set-up and preliminary trajectory control results

Conclusions

The results obtained so far, both in terms of definition of the hand architecture and in terms of experimental verification of practical design solutions, confirm the feasibility of the concept and the great interest towards further development of the proposed approach. Work is only at the beginning, but early results encourage going on, focusing the effort on mechanical design towards some primary needs:

- technological development, as the successful implementation of the proposed design concepts heavily depends on a skilled use of advanced materials and manufacturing processes;
- structural design optimization, in order to achieve with a good balance adequate strength and lifetime as well as an overall stiffness compatible with system modeling and control;
- application of a mechatronic approach, purposely oriented to an efficient integration of the sensory equipment into the compliant mechanical structure.

Acknowledgements

The authors gratefully acknowledge the activity of Stefano Monti and Giancarlo Nannoni, technicians at DIEM, for their invaluable contribution to prototype implementation and the company Cattini Engineering Plastics for consultancy on plastic materials moulding.

References

- [1] K. Lee, I. Shimoyama, "A skeletal Framework Artificial Hand Actuated by Pneumatic Artificial Muscles", Proc.1999 IEEE Int. Conf. On Robotics & Automation, Detroit, Michigan, May 1999.
- [2] Schulz, S.; Pylatiuk, C.; Bretthauer, G., "A new ultralight anthropomorphic hand", Proc. IEEE Int. Conf. on Robotics and Automation, Seoul, Korea, 2001, Page(s): 2437 -2441 vol.3
- [3] Haruhisa Kawasaki, Hisayuki Shimomura, Yuuji Shimizu, "Educational-industrial complex development of an anthropomorphic robot hand 'Gifu hand'", Advanced Robotics, Vol. 15, No. 3, pp. 357-363 (2001).
- [4] Butterfass, J.; Grebenstein, M.; Liu, H.; Hirzinger, G.: DLR-Hand II: Next Generation of a Dexterous Robot Hand, Proc. IEEE Int. Conf. on Robotics and Automation, Seoul, Korea, 2001
- [5] N.Fukaya, S. Toyama, T. Asfour, R. Dillmann "Design of the TUAT/Karlsruhe Humanoid hand", in Proc. IEEE/RSJ International conference on intelligent robots and systems, pp.1754-1759, 2000
- [6] J.P. Gazeau, S. Zeghloul, M. Arsicualt, J.P. Lallemand, "The LMS hand: force and position controls in the aim of fine manipulation of objects", in Proc. IEEE International conference on robotics and automation, pp. 2642-2648, 2001.
- [7] C.S. Lovchik and M.A. Diftler, "The Robonaut Hand: a Dexterous Robot Hand for Space", Proc. IEEE International Conference on Robotics and Automation, 1999, pp. 907-912.

- [8] R.O. Ambrose, H.Aldridge, R.S.Askew, R.R. Burrige, W.Bluethmann, M.Diftler, C.Lovchik, D.Magruder, and F.Rehmark," Robonaut: NASA's Space Humanoid", in IEEE Intelligent System, pp. 57-63, July / August 2000.
- [9] A. Zucchelli, "Reliability considerations on Robotic Hands", DIEM (Department of Mechanical Engineering, University of Bologna), Internal Communication, October 2002.
- [10]K.B. Shimoga, A.A. Goldenberg, " Soft Materials for Robotic Fingers" Proceeding of 1992 IEEE International Conference on Robotic and Automation, Nice, France, May 1992
- [11]N. Xydas, I. Kao, "Modelling of Contact Mechanics with Experimental Results for Soft Fingers", Proceeding of the 1998 IEEE, International Conference on Intelligent Robots and Systems, Victoria, B. C., Canada (1988)
- [12]N. Xydas, I. Kao, "Influence of Material Properties and Fingertip Size on the Power-Law Equation for Soft Fingers", Proceeding of the 2000 IEEE, International Conference on Intelligent Robots and Systems.
- [13]L.L.Howell, "Compliant mechanisms", John Wiles & Sons, inc.U.S.A., 2001, ISBN: 0-471-38478-X..
- [14]L.L.Howell, A. Midha, "A Method for the Design of Compliant Mechanisms With Small-Length Flexural Pivots", ASME Journal of Mechanical Design 116(1), 280-290 (1994).
- [15]L.L.Howell, A. Midha, "Parametric Deflection Approximations for End-Loaded, Large-Deflection Beams in Compliant Mechanisms", ASME Journal of Mechanical Design 117(1),156-165 (1995).
- [16]J M. Goldfarb, N. Celanovic, "A flexure-based gripper for small-scale manipulation", Robotica (1999), Volume 17, pp.181-187.
- [17]F. Lotti, G. Vassura, "A Novel Approach to Mechanical Design of Articulated Fingers for Robotic Hands", in Proceeding of the 2002 IEEE/RSJ, International Conference on Intelligent Robots and Systems, Lausanne, Switzerland (2002).
- [18]F. Lotti, G. Vassura, "Sviluppo di Soluzioni Innovativeper la Struttura Meccanica di Dita Articolate per Mani Robotiche", in Proceeding of the XXXI National Conference on Stress Analysis, AIAS 2002, Parma, Italy, September 18-21 (2002) (in italian).
- [19]F. Lotti, G. Vassura, "Design aspects for advanced robot hands: mechanical design", Lecture notes of Tutorial T1, IROS 2002, Lausanne, Switzerland, October 30, 2002
- [20]T. Doersam and P. Duerrschmied, "Compensation of Friction in Mechanical Drives for a Three Fingered Robot Gripper", in Proc. IEEE/RSJ Int. Conf. on Intelligent Robots and Systems '96, IROS 96, Osaka, Japan 1996.
- [21]P. Tomei, "A Simple PD Controller fo Robots with Elastic Joints", in IEEE Transactin on Automatic Control, Vol. 36, No. 10, October 1991.
- [22]N. Hogan, "On the Stability of Manipulators PerformingContact Tasks", in IEEE Journal of Robotics and Automation, Vol. 4, No. 6, December 1988.
- [23]S.D. Eppinger and W.P. Seering, "Three Dynamic Problems in Robot Force Control", in IEEE Transactions on Robotics and Automation, Vol. 8, No. 6, December 1992.